

- INSTRUCTION MANUAL -

QUILTON

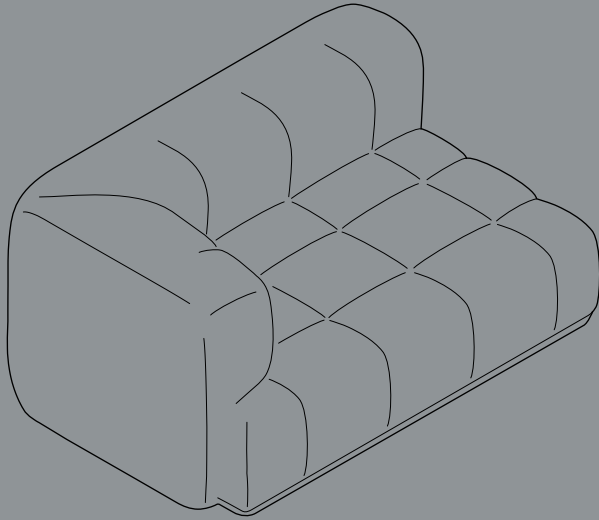

DESIGN BY DOSHI LEVIEN

HAY

1.

Detach the handles by unscrewing the knobs.

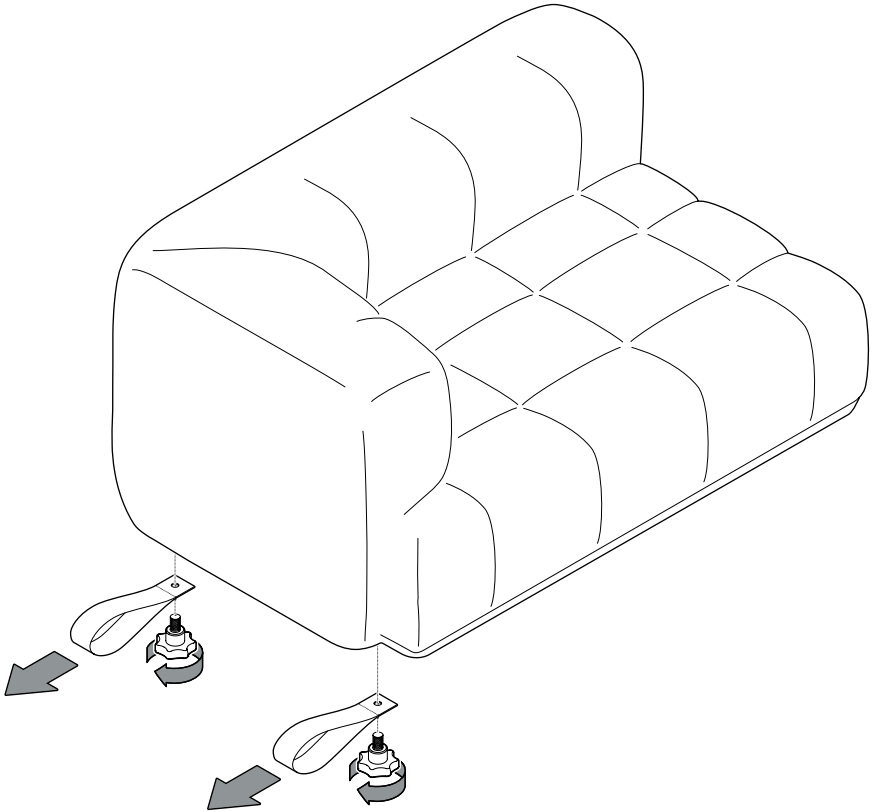

2.

To lock two modules together, connect the fittings by interlocking them as illustrated. Once they are connected together, give the module an extra push to make sure it is firmly locked in place.

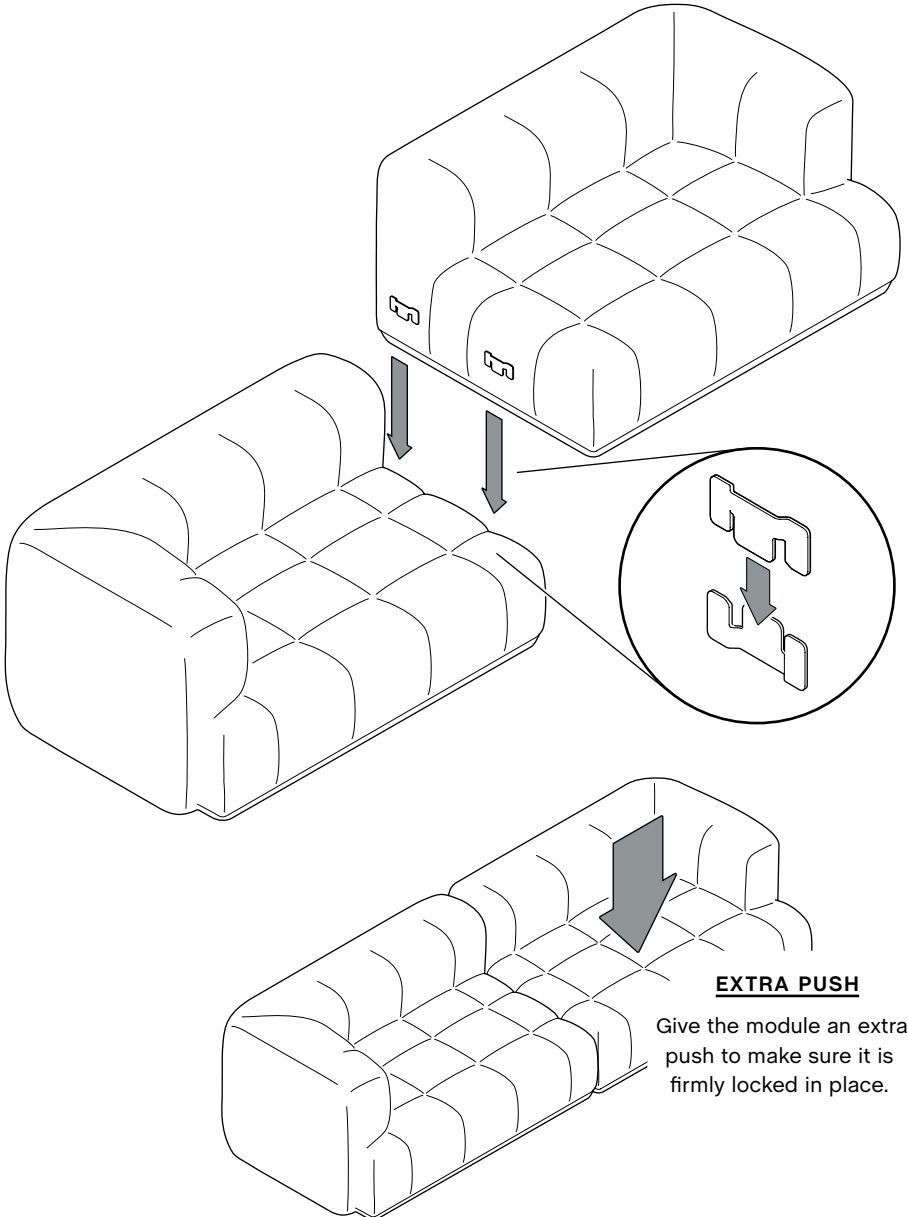

3.

Remove creases by pushing the fabric into the corner and down in between the seat and back.

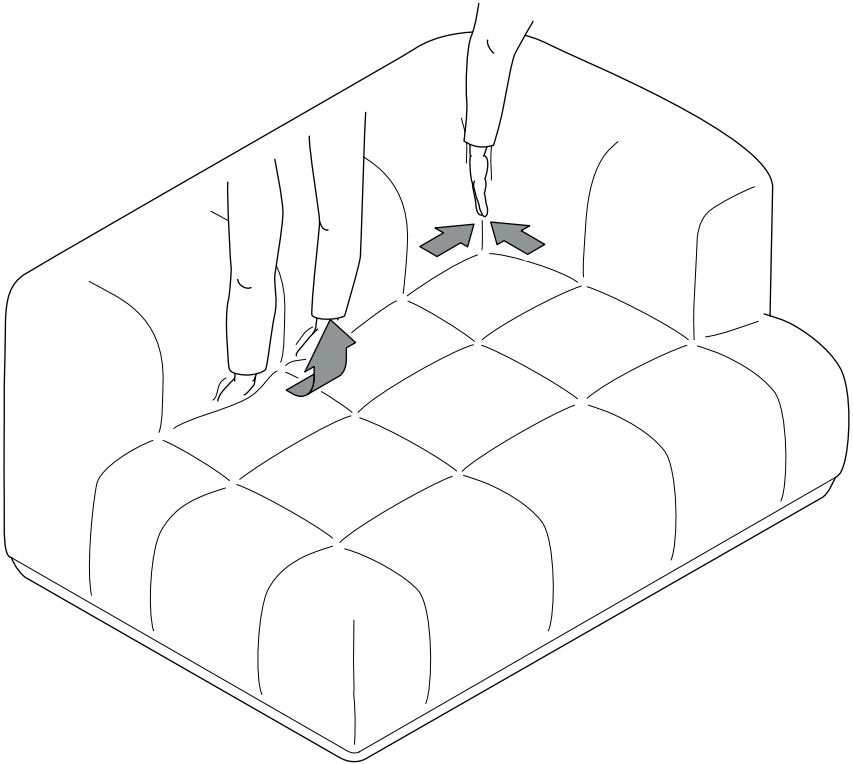

- CARE & MAINTENANCE -

Our Care & Maintenance offers guidance for optimal maintenance of your HAY product. It includes advice and instructions on cleaning and caring for specific materials to prolong the life of your furniture.



Please find our Care & Maintenance guide by scanning the QR code



You can find more relevant information on Quilton by scanning the QR code

You can also find the same information here
hay.dk/downloads

Havnen 1 8700 Horsens Denmark
+45 4282 0282 / hay@hay.com

14/10/2021

HAY