



WITH
LODES

SPRING

CATEGORY > Floor lamp

Light source

LED included

Spring Terra

- ↘ LED
- ↘ 2700K
- ↘ 100-240V ~50/60HZ
- ↘ 30.5W
- ↘ CRI 90
- ↘ MacAdam 3-Step
- ↘ 3050lm

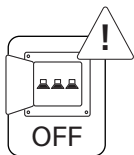

EN Before installing the device and, in any case, before any maintenance work, always disconnect the power supply.

IT Prima di installare l'apparecchio e comunque prima di ogni manutenzione togliere la tensione di alimentazione.

FR Avant d'installer le luminaire et avant toute opération de maintenance, couper l'alimentation électrique.

DE Vor der Installation des Geräts und in jedem Fall vor jeder Wartung ist die Stromversorgung zu unterbrechen.

ES Antes de instalar el aparato y en cualquier caso antes de cada mantenimiento cortar la alimentación.

RU Перед установкой прибора и перед проведением техобслуживания отключите электропитание.

ZH 安装照明设备以及进行任何维护之前均应断开电源。

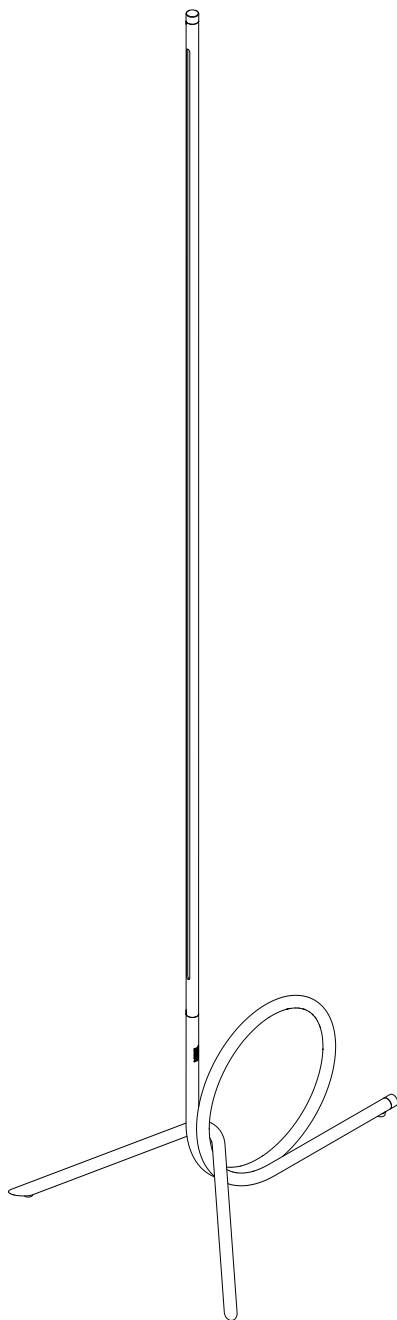

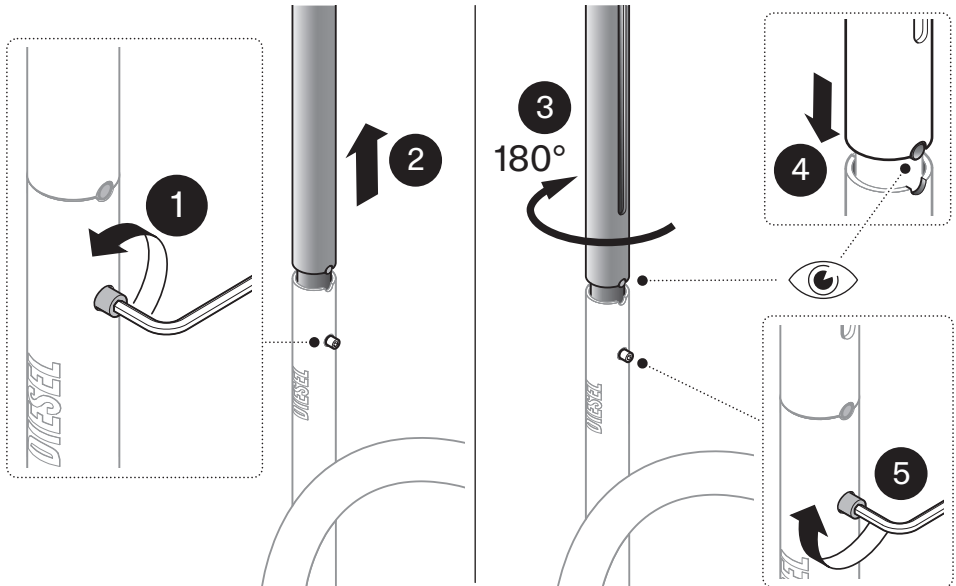
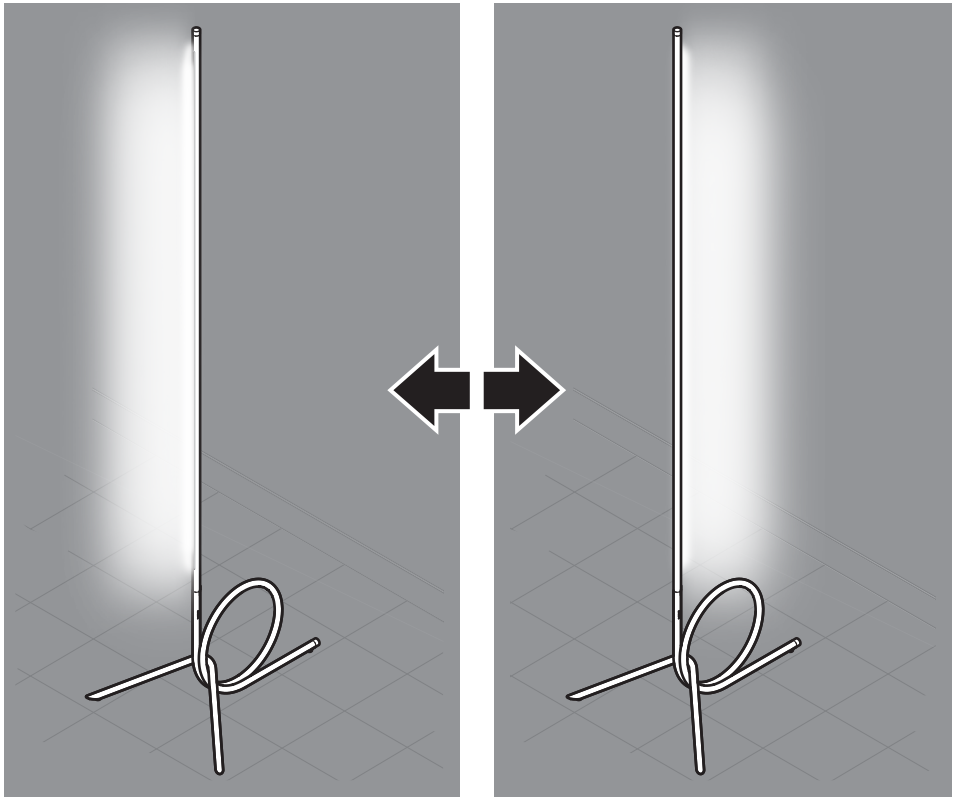

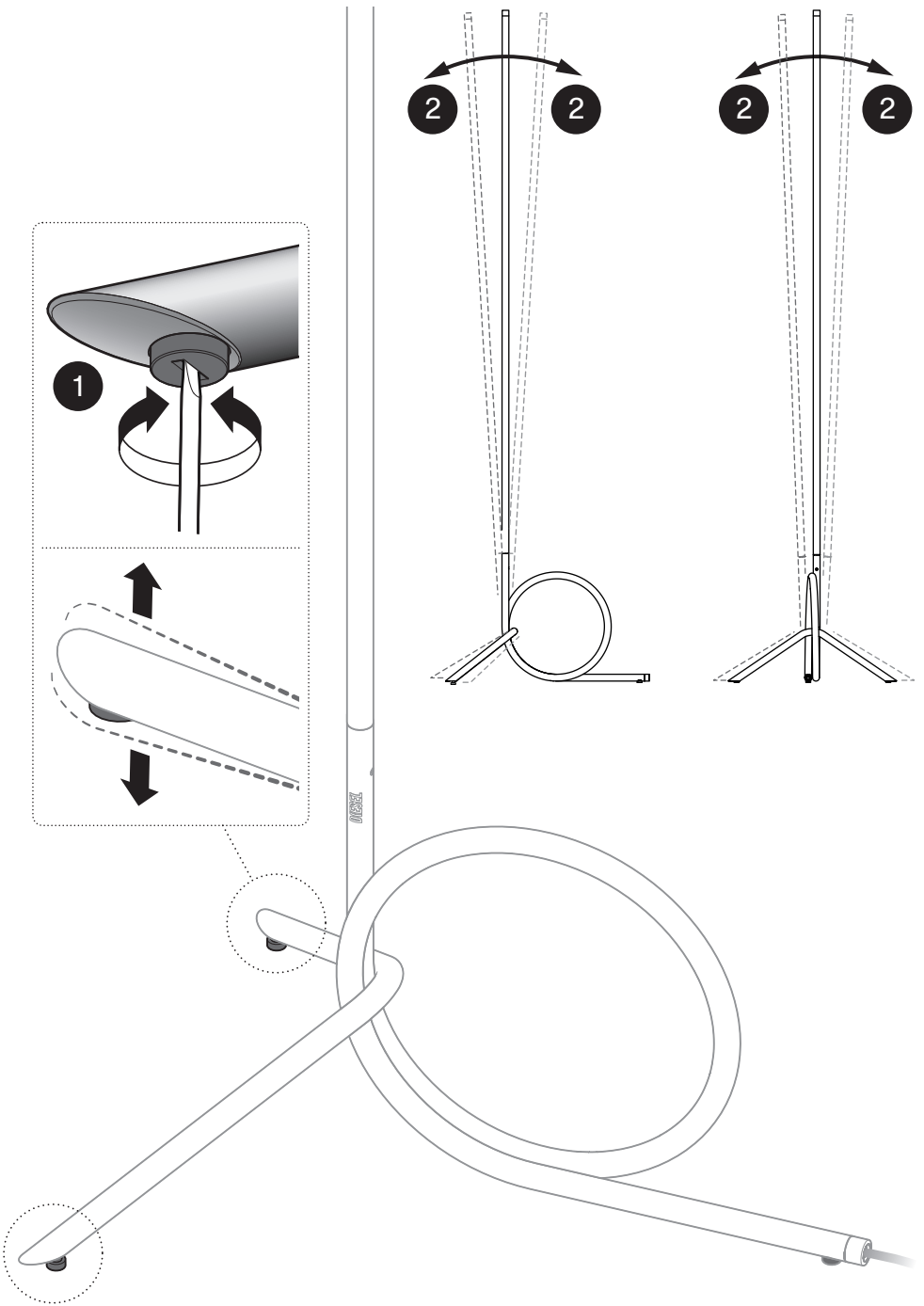
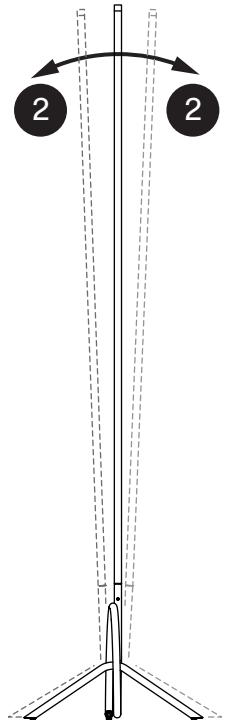
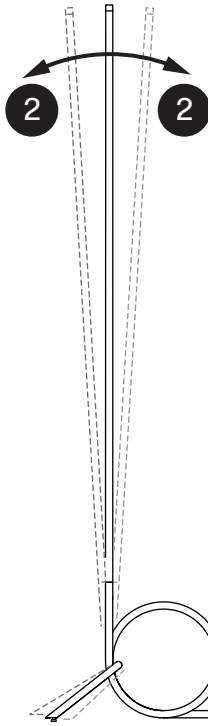
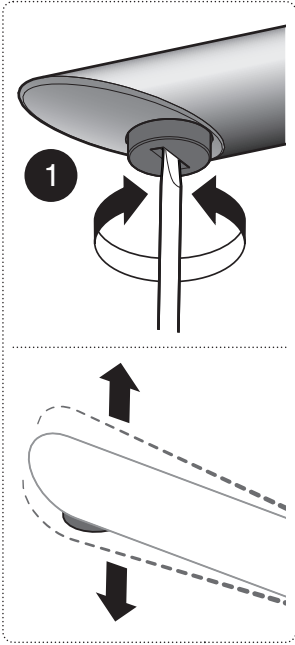

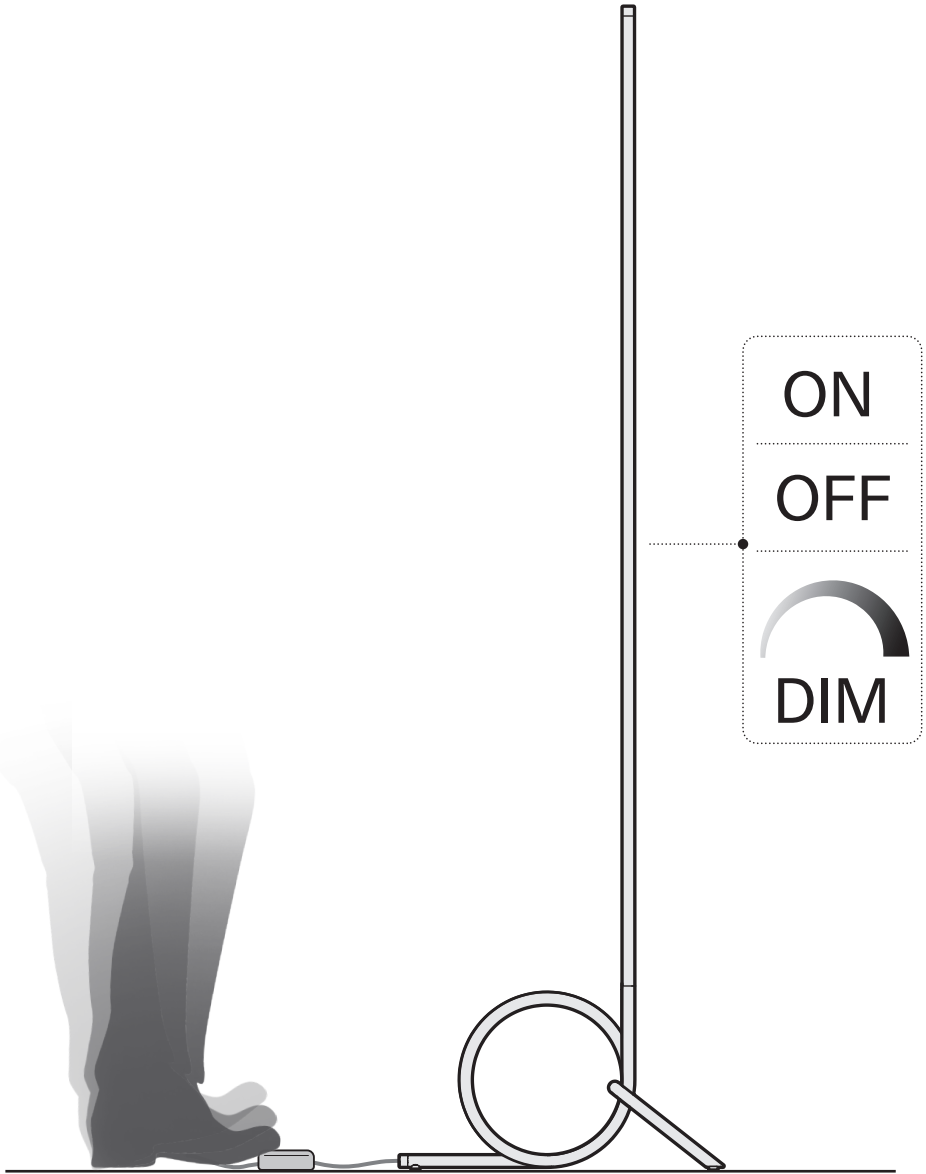

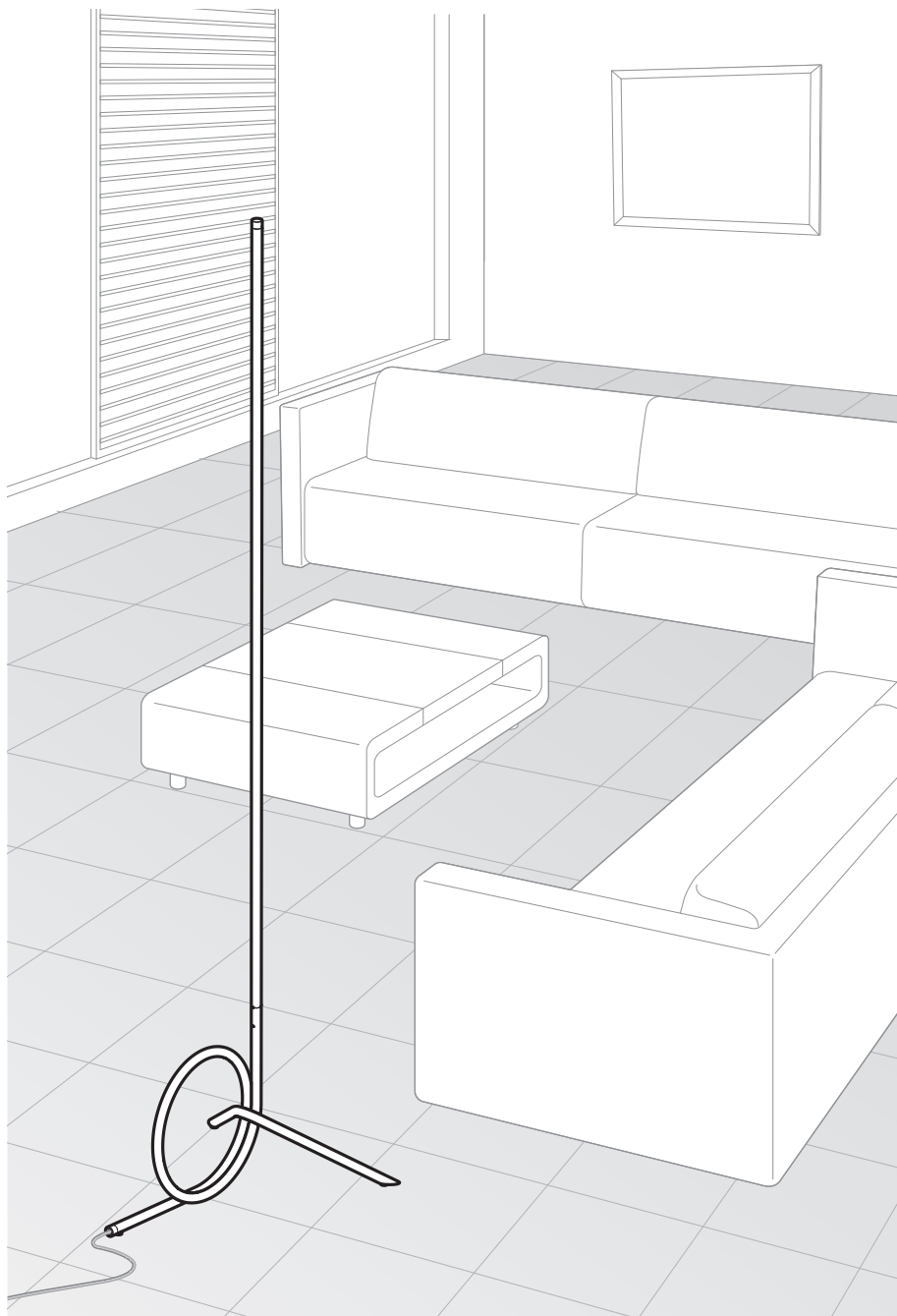

Keep these instructions for future reference. The device must be installed by qualified personnel only.

● WARRANTY

The products are covered by a warranty for material and manufacturing defects for a period of 12 months from delivery, except in cases where the purchaser is an individual, in which case the warranty period shall be 24 months. During this warranty period, Lodes will repair or replace, at its discretion, any product that is proven to be defective. This warranty does not apply to any damage resulting from accidents, alterations, tampering, misuse, negligence or improper use, or that has been caused by incorrect installation or incorrect maintenance work carried out by unauthorised individuals. The device must not be installed in positions or used in ways other than those indicated in the installation instructions. Any modification may compromise safety and cause the product to become dangerous. Lodes shall therefore not be held liable for any damages caused by alterations or tampering or the product not being used/installed in compliance with the installation instructions, also in the event of the electrical system and/or the capacity of said system not being suitable.

⚠ WARNING

► Clean the product using a soft cloth, slightly dampened with soap or detergent, preferably diluted in water. Never use ethyl alcohol or detergents containing even small amounts of acetone, trichloroethylene, ammonia

and solvents in general.

- The device poses no photobiological hazard.
 - When the lamp is switched on, and between being switched off and cooling down, the light source and the nearby components may heat up to high temperatures.
 - If the external flexible cable of this device is damaged, it must only be replaced by the manufacturer, its support service or by equivalent qualified personnel, in order to avoid danger.
 - The device must not be installed in positions other than those specified in the assembly instructions.
 - This appliance must only be used indoors. Do not use in damp, saline or aggressive environments.
 - CAUTION: IMPORTANT SAFETY INSTRUCTIONS
- This portable luminaire has a polarised plug (one blade is wider than the other) as a feature to reduce the risk of electric shock. This plug will fit in a polarised outlet only one way. If the plug does not fit fully in the outlet, reverse the plug. If it still does not fit, contact a qualified electrician. Do not use with an extension cord unless the plug can be fully inserted. Do not modify the plug in any way.
- Turning the power off using the light switch is not sufficient to prevent electrical shock.
 - The luminaire is not intended to support external weight other than the provided diffusers or other components.
 - This product contains an energy efficiency class F light source.

⚠ CAUTION

► To reduce the risk of fire, electrical shock, exposure to excessive UV radiation or

injury, do not look directly at the lighted lamp and do not remain in light if skin feels warm.

► This product must be installed in accordance with the applicable installation code by a person familiar with the construction and operation of the product and the hazards involved. To ensure the correct and safe functioning of the light fitting, make sure it is properly earthed, where required.

⚠ RISK OF FIRE

► Never place flammable material close to your fixture.

Italiano

Conservare queste istruzioni per una manutenzione futura. L'apparecchio deve essere installato da personale qualificato.

● GARANZIA

I prodotti sono coperti da garanzia per difetti di materiale e/o fabbricazione per un periodo di 12 mesi dalla consegna, salvo nei casi in cui l'acquirente risulti essere una persona fisica e in quel caso il periodo di garanzia sarà di 24 mesi. Durante tale periodo Lodes riparerà o sostituirà a sua discrezione, i prodotti che hanno dato prova di difetto. Questa garanzia non è applicata a danni risultanti dall'incidente, alterazione, manomissione, abuso, negligenza o da uso non conforme ovvero errata installazione o errata manutenzione operata da personale non autorizzato. L'apparecchio non deve essere installato in posizioni o in applicazioni diverse da quelle indicate nelle istruzioni di installazione. Ogni modifica può compromettere la sicurezza rendendo l'apparecchio

pericoloso. Lodes, declina pertanto ogni responsabilità per danni derivanti da alterazioni, manomissioni e da uso/installazione del prodotto non conforme alle istruzioni di installazione anche nel caso in cui l'impianto elettrico e/ o la portata dello stesso non risultino idonei.

ATTENZIONE

► Pulire il prodotto con un panno morbido leggermente inumidito di sapone o detersivi liquidi neutri, meglio se diluiti in acqua. Evitare assolutamente l'uso di alcool etilico o di detersivi contenenti anche in piccole quantità acetone, trielina, ammoniacca e solventi in generale.

► L'apparecchio è esente dal rischio di emissione fotobiologica.

► Quando la lampada è accesa e nel periodo tra lo spegnimento e il raffreddamento, la fonte luminosa e i componenti vicini possono raggiungere temperature elevate.

► Se il cavo flessibile esterno di questo apparecchio è danneggiato, deve essere sostituito esclusivamente dal costruttore, dal suo servizio di assistenza, o da personale qualificato equivalente, al fine di evitare pericoli.

► L'apparecchio non deve essere installato in posizioni diverse da quelle indicate nelle istruzioni di montaggio.

► Questo apparecchio deve essere utilizzato solo in ambienti interni; non utilizzare in atmosfere saline o aggressive.

► **ATTENZIONE, INFORMAZIONI IMPORTANTI SULLA SICUREZZA**

Questa lampada portatile è dotata di una spina polarizzata (con una lama più ampia dell'altra) in grado di ridurre il rischio di scosse elettriche. La spina può essere inserita in una presa polarizzata soltanto

in un modo. Qualora la spina non si inserisca correttamente a fondo, invertire la posizione e se il problema persiste contattare un tecnico qualificato. Non utilizzare mai con una prolunga salvo in caso di corretto e completo inserimento della spina. Non modificare la spina.

► Lo spegnimento dell'apparecchio dall'interruttore non è sufficiente a evitare il rischio di scosse elettriche.

► La lampada non è concepita per sostenere un peso esterno diverso da quello dei diffusori o di altri componenti forniti in dotazione.

► Questo prodotto contiene una sorgente luminosa di classe di efficienza energetica F.

ATTENZIONE

► Al fine di ridurre il rischio di incendio, scosse elettriche, un'esposizione eccessiva alle radiazioni UV o lesioni, evitare di fissare direttamente la luce della lampada e allontanarsi qualora si avverta una sensazione di calore sulla pelle.

► Questo prodotto deve essere installato conformemente al manuale di installazione applicabile da un soggetto con una buona conoscenza delle istruzioni per l'installazione e il funzionamento del prodotto nonché dei rischi connessi. Per garantire un funzionamento corretto e sicuro dell'apparecchio di illuminazione, assicurarsi che sia provvisto, dove richiesto, di una messa a terra adeguata.

RISCHIO DI INCENDIO

► Non avvicinare materiali infiammabili all'apparecchio.

Français

Conservez ces instructions pour une maintenance future. L'appareil doit être installé par un personnel qualifié.

● **GARANTIE**

Les produits sont couverts par une garantie pour les défauts de matériau et/ou de fabrication pour une période de 12 mois à compter de la livraison, sauf si l'acquéreur est une personne physique. Le cas échéant, la période de garantie est de 24 mois. Pendant cette période, Lodes réparera ou remplacera, à sa discrétion, les produits qui se sont avérés défectueux.

Cette garantie ne couvre pas les dommages résultant d'un accident, d'une altération, d'une intervention non-autorisée, d'un abus, d'une négligence ou d'une utilisation non-conforme, voire d'une installation ou d'une maintenance incorrecte effectuée par un personnel non-autorisé. L'appareil ne doit pas être installé dans des positions ou pour des applications autres que celles indiquées dans les instructions de montage. Toute modification peut compromettre la sécurité de l'appareil et le rendre dangereux. Par conséquent, Lodes décline toute responsabilité pour les dommages dérivant d'altérations, d'interventions non-autorisées et d'une utilisation/installation du produit non-conforme aux instructions d'installation, même dans le cas où l'installation électrique et/ ou sa portée ne sont pas appropriées.

ATTENTION

► Nettoyez le produit avec un chiffon doux, légèrement imbibé de savon ou de

détergent, préférablement dilués dans de l'eau. Évitez absolument d'utiliser de l'alcool éthylique ou de détergents contenant même de petites quantités d'acétone, de trichloréthylène, d'ammoniac et de solvants en général.

▶ L'appareil est exempt de risque d'émission photobiologique.

▶ Lorsque la lampe est allumée et dans le laps de temps entre l'arrêt et le refroidissement, la source lumineuse et les composants en contact peuvent atteindre de très hautes températures.

▶ En cas d'endommagement du câble extérieur flexible de cet appareil, le faire remplacer exclusivement par le service après-vente du fabricant ou par un personnel qualifié équivalent, afin d'éviter tout risque.

▶ L'appareil ne doit pas être installé dans des positions autres que celles indiquées dans les instructions de montage.

▶ Cet appareil doit être utilisé uniquement en intérieur ; ne pas l'utiliser dans des environnements humides, salins ou agressifs.

▶ **ATTENTION, INSTRUCTIONS DE SÉCURITÉ IMPORTANTES**

Ce luminaire portable est doté d'une fiche polarisée (une lame plus large que l'autre) afin de réduire le risque de secousse électrique. Cette fiche se branche dans une prise polarisée à une seule voie. Si la fiche ne rentre pas complètement dans la prise, l'inverser. Si le problème persiste malgré l'inversion, contacter un électricien qualifié. Ne jamais utiliser de rallonge à moins que la fiche ne puisse être complètement branchée. Ne pas modifier la prise.

▶ Couper l'alimentation par l'interrupteur ne suffit pas à prévenir les secousses

électriques.

▶ Les luminaires ne sont pas conçus pour supporter un poids externe autre que les diffuseurs fournis ou d'autres composants.

 **ATTENTION**

▶ Pour réduire le risque d'incendie, de secousse électrique, d'exposition excessive au rayonnement UV ou de blessure, éviter de fixer directement la lumière de la lampe et s'éloigner en cas de sensation de chaleur sur la peau.

▶ Ce produit doit être installé dans le respect du code d'installation en vigueur par une personne connaissant la fabrication et le fonctionnement du produit et les risques connexes. Afin de garantir le fonctionnement correct et sûr du luminaire, s'assurer qu'il est muni, lorsque cela est requis, d'une mise à la terre adéquate.

▶ Ce produit contient une source lumineuse à efficacité énergétique classe F.

 **RISQUE D'INCENDIE**

▶ Ne jamais placer de matériaux inflammables à proximité du luminaire.

Deutsch

Bewahren Sie diese Anweisungen zum späteren Nachschlagen auf. Nur von einem qualifizierten Elektrofachmann installieren lassen.

● GARANTIE

Garantie: Die Produkte unterliegen einer Garantie für Material- und/oder Herstellungsfehler für einen Zeitraum von 12 Monaten ab Lieferung, außer in Fällen, in denen der Käufer eine natürliche Person ist; in diesem Fall beträgt die

Garantiezeit 24 Monate.

Während dieses Zeitraums repariert oder tauscht Lodes, nach eigenem Ermessen, defekte Produkte aus. Diese Garantie gilt nicht für Schäden, die durch Unfall, Veränderung, Manipulation, falschen Einsatz, Nachlässigkeit oder nicht bestimmungsgemäßen Gebrauch sowie falscher Installation oder Wartung durch nicht autorisiertes Personal beruhen. Das Gerät darf nicht in Positionen oder Anwendungen installiert werden, die von denen in der Montageanleitung angegebenen abweichen. Jede Änderung kann die Sicherheit beeinträchtigen und das Gerät gefährlich machen. Lodes lehnt daher jede Verantwortung für Schäden ab, die aus Änderungen, Manipulationen und aus einer Benutzung/Installation des Produkts resultieren, die nicht den Montageanweisungen entsprechen, auch im Falle, dass das elektrische System und/oder die Leistungsfähigkeit desselben nicht geeignet sind.

 **WARNING**

▶ Reinigen Sie das Produkt mit einem weichen Tuch, das leicht mit Seife oder Reinigungsmittel angefeuchtet ist. Verwenden Sie niemals Alkohol oder Reinigungsmittel, die auch nur geringe Mengen an Aceton, Trichlorethylen, Ammoniak oder Lösungsmitteln enthalten.

▶ Das Gerät ist frei von der Gefahr einer fotobiologischen Emission.

▶ Bei eingeschalteter Leuchte und in der Zeit zwischen Ausschalten und Abkühlen können die Leuchtmittel und angrenzende Bauteile hohe Temperaturen erreichen.

▶ Wenn das flexible Außenkabel dieses Geräts beschädigt ist, darf es

nur durch den Hersteller, seinen Kundendienst oder gleichwertiges Fachpersonal ausgetauscht werden, um Gefahren zu vermeiden.

▶ Das Gerät darf nicht in anderen als den in der Montageanleitung angegebenen Positionen installiert werden.

▶ Dieses Gerät darf nur in Innenräumen verwendet werden; nicht in salzhaltigen oder aggressiven Umgebungen verwenden.

▶ ACHTUNG, WICHTIGE SICHERHEITSHINWEISE

Diese tragbare Leuchte ist mit einem gepolten Stecker (ein Stift breiter als der andere) versehen, als Merkmal zur Verringerung eines elektrischen Stromschlagrisikos. Dieser Stecker passt nur in einer Richtung in eine gepolte Steckdose. Falls der Stecker nicht vollständig in die Steckdose eingeführt werden kann, ist dieser umzudrehen. Wenn er dann immer noch nicht passen sollte, ist ein qualifizierter Elektriker zu kontaktieren. Die Verwendung mit einem Verlängerungskabel ist nur zulässig, wenn der Stecker vollständig eingesteckt werden kann. Den Stecker nicht manipulieren.

▶ Das Ausschalten über den Lichtschalter reicht nicht aus, um einen elektrischen Stromschlag zu vermeiden.

▶ Die Leuchte ist nicht für die Belastung durch andere als die mitgelieferten Abdeckungen oder andere Komponenten vorgesehen.

▶ Dieses Produkt enthält ein Leuchtmittel der Energieeffizienzklasse F.

⚠ ACHTUNG

▶ Um das Risiko von Feuer, elektrischem Stromschlag, übermäßiger UV-Strahlung oder Verletzungen zu verringern, darf nicht direkt in die eingeschaltete

Leuchte geblickt und nicht im Lichtbereich verweilt werden, wenn sich die Haut warm anfühlt.

▶ Dieses Produkt muss in Übereinstimmung mit den geltenden Installationsvorschriften von einer Fachkraft installiert werden, die mit guten Kenntnissen hinsichtlich des Einbaus und dem Betrieb des Produkts sowie den damit verbundenen Gefahren vertraut ist. Um die korrekte und sichere Funktion der Leuchte zu gewährleisten, ist gegebenenfalls sicherzustellen, dass diese ordnungsgemäß geerdet ist.

⚠ BRANDGEFAHR

▶ Niemals entflammables Material in der Nähe des Gerätes platzieren.

Español

Conserve estas instrucciones para un futuro mantenimiento. El aparato debe ser instalado solo por personal cualificado.

● GARANTÍA

Los productos están cubiertos por una garantía respecto a cualquier defecto de material y/o elaboración durante 12 meses a partir de la fecha de entrega, excepto cuando el comprador sea una persona física en cuyo caso el período de garantía durará 24 meses. Durante dicho período Lodes reparará o sustituirá, a su discreción, los productos que estén defectuosos. Esta garantía no se aplica a daños como consecuencia de accidentes, alteraciones, manipulaciones, abuso, negligencia, uso no conforme o instalación o mantenimiento incorrecto por parte de personal no autorizado. El aparato no debe instalarse en posiciones o aplicaciones distintas a las que se

indican en las instrucciones de instalación. Cualquier modificación puede poner en peligro la seguridad y hacer que el aparato sea peligroso. Por lo tanto, Lodes no se hace responsable de los daños causados por alteraciones, manipulaciones y el uso/la instalación del producto que no sea conforme con las instrucciones de instalación incluso en caso de que la instalación eléctrica y/o su capacidad no sean idóneas.

⚠ ATENCIÓN

▶ Limpie el producto con un paño suave, ligeramente humedecido con jabón o detergentes líquidos neutros, mejor si están diluidos en agua. Nunca use alcohol etílico o detergentes que contengan incluso pequeñas cantidades de acetona, tricloroetileno, amoníaco y solventes en general.

▶ El aparato está libre del riesgo de emisión fotobiológica.

▶ Cuando la lámpara está encendida y durante el tiempo que transcurre entre el apagado y el enfriamiento, la fuente luminosa y los componentes próximos pueden alcanzar altas temperaturas.

▶ Si el cable flexible exterior de este aparato ha sufrido daños, lo debe sustituir exclusivamente el fabricante, el servicio de asistencia o personal cualificado para evitar cualquier peligro.

▶ El aparato no se debe instalar en otras posiciones que no sean las que se indican en las instrucciones de instalación.

▶ Este aparato debe utilizarse solamente en interiores; no utilizar en ambientes salinos o agresivos.

▶ ATENCIÓN, INFORMACIÓN IMPORTANTE DE SEGURIDAD Esta lámpara portátil está dotada de un enchufe

polarizado (con una clavija más ancha que otra) capaz de reducir el riesgo de descargas eléctricas. El enchufe se puede conectar en una toma polarizada solamente de una forma. En caso de que el enchufe no se conecte a fondo correctamente, invierta la posición y si el problema persiste póngase en contacto con un técnico cualificado. Nunca lo utilice con un alargador a no ser que el enchufe esté correcta y completamente conectado. No modifique el enchufe.

- ▶ Apagar el aparato con el interruptor no es suficiente para evitar el riesgo de descargas eléctricas.
- ▶ La lámpara no se ha concebido para soportar un peso externo distinto al de los difusores u otros componentes suministrados.
- ▶ Este producto contiene una fuente luminosa con clase de eficiencia energética F.

ATENCIÓN

- ▶ Para reducir el riesgo de incendio, descargas eléctricas, una exposición excesiva a las radiaciones UV o lesiones, evite mirar directamente la luz de las lámparas y aléjese cuando note una sensación de calor en la piel.
- ▶ Este producto tiene que instalarlo de acuerdo con el manual de instalación aplicable un sujeto que conozca bien las instrucciones de instalación, el funcionamiento del producto y los riesgos relacionados. Para garantizar que el aparato de iluminación funcione correctamente y de forma segura, cerciórese de que esté dotado, cuando sea necesario, de una puesta a tierra adecuada.

PELIGRO DE INCENDIO

- ▶ No aproxime materiales

inflamables al aparato.

Русский

Храните эти инструкции для дальнейшего использования. Для установки только квалифицированным электриком.

● Гарантия

Изделия имеют гарантию на срок 12 месяцев с момента поставки, на дефекты материала и/или дефекты изготовления, за исключением тех случаев, когда покупатель является физическим лицом, поскольку в этих случаях гарантийный период составляет 24 месяца. Во время этого гарантийного периода Lodes отремонтирует или заменит, на свое усмотрение, изделия, которые оказались дефектными. Эта гарантия не покрывает любые повреждения, причиненные в результате несчастного случая, манипуляций, внесения изменений, злоупотребления, небрежности, эксплуатации с нарушением норм или неправильного монтажа или техобслуживания со стороны не уполномоченного лица. Оборудование не следует устанавливать в положении или для применения, отличающегося от указанного в инструкциях по монтажу. Любые изменения могут поставить под угрозу безопасность, делая оборудование опасным. Lodes не несет никакой ответственности за ущерб, связанный с изменениями, манипуляциями и использованием / монтажом оборудования

не в соответствии с инструкциями по монтажу, а также в том случае, если электрическая установка или ее мощность являются не соответствующими.

ПРЕДУПРЕЖДЕНИЕ

- ▶ Выполните очистку продукта с помощью мягкой ткани, слегка смоченной мылом или моющим средством, разбавленным водой. Никогда не используйте этиловый спирт или другие средства, содержащие даже небольшие количества ацетона, трихлорэтилена, аммиака и растворителя.
- ▶ Оборудование не представляет риска фотобиологических излучений.
- ▶ Когда лампа включена и в период между включением и охлаждением, источник света и расположенные рядом с ним компоненты могут нагреваться до высоких температур.
- ▶ Если внешний гибкий кабель данного устройства поврежден, во избежание опасности он должен быть заменен только производителем, его сервисной службой или другим квалифицированным персоналом.
- ▶ Запрещается устанавливать изделие в положениях, отличных от указанных в инструкции по монтажу.
- ▶ Это оборудование следует использовать только во внутренних помещениях; не использовать в соленой или агрессивной среде.
- ▶ ВНИМАНИЕ, ВАЖНЫЕ ИНСТРУКЦИИ ПО БЕЗОПАСНОСТИ Этот переносной светильник имеет

поляризованную вилку (один штырь шире другого), что снижает риск поражения электрическим током. Данная вилка подходит к поляризованной розетке только в одном положении. Если вилка не полностью входит в розетку, переверните вилку. Если вилка по-прежнему не подходит, обратитесь к квалифицированному электрику. Никогда не используйте удлинитель, если вилка не может быть полностью вставлена. Не изменяйте вилку.

- ▶ Выключения питания с помощью выключателя света недостаточны для предотвращения поражения электрическим током.
- ▶ Светильники не предназначены для поддержки постороннего веса, за исключением поставляемых с ними диффузоров или других компонентов.

ВНИМАНИЕ

- ▶ Для того, чтобы снизить риск возгорания, поражения электрическим током, чрезмерного воздействия ультрафиолетового излучения или травм, не смотрите прямо на горящую лампу, не оставайтесь под воздействием света, если возникает ощущение тепла на коже.
- ▶ Это изделие должно быть установлено в соответствии с применимыми правилами монтажа лицом, знакомым с конструкцией и работой изделия, а также со связанными с ним опасностями. Убедитесь, что осветительный прибор заземлен, если это требуется, чтобы гарантировать его правильную и безопасную работу.
- ▶ Этот светильник содержит

источник освещения с классом энергетической эффективности F.

РИСК ВОЗГОРАНИЯ

- ▶ Никогда не размещайте горючие материалы рядом с изделием.

简体中文

请妥善保管本说明书以便将来查阅。应由具备资质的人员安装此设备。

● 保修

Lodes 产品自交付之日起可在12个月内享有材料和/或制造缺陷方面的保修,如买方是自然人,则保修期为24个月。在此期间,Lodes 将自行决定维修或更换已证实存在缺陷的产品。本保修不适用于因事故、改动、篡改、滥用、疏忽或使用不当,以及由未经授权人员进行的不正确安装或不正确维护而造成的损坏。设备不得安装于安装说明未指定的位置或应用领域中。任何改动都可能危及安全,使灯具陷入危险状况。因此,即使在电气系统和/或其范围不适合的情况下,Lodes 也对因产品改动和篡改以及不符合安装说明而进行的产品使用/安装而造成的损坏概不负责。

警告

- ▶ 用一块稍稍浸湿 液或中性清洗剂(最好稀释)的湿布清洁产品。禁止使用含有乙醇或含有(包括小剂量)丙酮、三氯乙烯、氨、一般剂的清洗剂。
- ▶ 本设备没有光生物发射的危险。
- ▶ 当灯具点亮及处于关闭和冷却的间隙期时,光源部位及邻近组件可达到较高温度。
- ▶ 如本设备的外部柔性电缆已损,为避免造成危险,则应仅由制造商、协助服务部门或具备同等效力的合格人员对其进行更换。
- ▶ 不得将设备安装在组装说明指定位置之外的位置。
- ▶ 本设备仅可在室内使用;请勿在含盐或腐蚀性环境中使用。
- ▶ 小心,重要安全指示
这种便携式灯具带有一个极化插头(一个叶片宽于另一个)作为降低触电风险的功能。该插头只能以一种方式插入极化插座。如插

头无法完全插入插座,请将插头反转。如仍然无法插入,请联系一位具备合格资质的电工。除非插头可完全插入,否则切勿与延长线一同使用。请勿改动插头。

- ▶ 使用灯具开关将电源关闭,这不足以防止电击。
- ▶ 除了所提供的漫射器或其他组件外,灯具不得用于支撑外部重量。
- ▶ 本产品包含能效等级为F的光源。

请注意

- ▶ 为减少火灾、电击、过度暴露于紫外线辐射或受伤的风险,请避免直视灯光,如皮肤感觉灼暖,则请勿停留于光线下。
- ▶ 本产品须由熟悉产品结构和操作以及相关危险的人员按照适用的安装规范进行安装。为保证灯具的正确和安全运行,请确保在需要时将其正确接地。

失火风险

- ▶ 请勿将易燃材料放在您的灯具临近处。

Legend of symbols



- EN Danger of electric shock
- IT Pericolo di scossa elettrica
- FR Risque de secousse électrique.
- DE Gefahr eines elektrischen Stromschlags.
- ES Peligro de descarga eléctrica.
- RU Опасность электрического разряда.
- ZH 电击危险。



- EN This certifies that the product complies with the provisions of EC directives.
- IT Attesta la conformità del prodotto alle disposizioni delle direttive comunitarie.
- FR Atteste la conformité du produit aux dispositions des directives communautaires.
- DE Die Konformität des Produkts mit den Bestimmungen der Gemeinschaftsrichtlinien wird bescheinigt.
- ES Certifica la conformidad del producto con las disposiciones de las directivas comunitarias.
- RU Удостоверяет соответствие изделия положениям директив Сообщества.
- ZH 证明产品符合欧盟指令的规定。



- EN EAC marking confirms the compliance of the goods with the Eurasian Customs Union.
- IT EAC un marchio che attesta la conformità delle merci alle norme dell'Unione doganale euroasiatica.
- FR EAC marking confirms the compliance of the goods with the Eurasian Customs Union.
- DE EAC ist eine Kennzeichnung, die bescheinigt, dass die Waren den Vorschriften der Eurasischen Zollunion entsprechen.
- ES EAC es un sello que certifica la conformidad de las mercancías con las normas de la unión aduanera euroasiática.
- RU EAC - знак, удостоверяющий соответствие товаров правилам Евразийского таможенного союза.
- ZH EAC是一项证明商品符合欧亚关税同盟规范的标志。



- EN Device in which protection against electric shock is based solely on double and/or reinforced insulation. These devices do not have earthing devices.
- IT Apparecchio nel quale la protezione contro la scossa elettrica si basa unicamente sul doppio isolamento e/o isolamento rinforzato. Questi apparecchi non prevedono dispositivi per la messa a terra.
- FR Appareil dont la protection contre les secousses électriques se base uniquement sur la double isolation et ou l'isolation renforcée. Ces appareils ne prévoient pas de dispositifs pour la mise à la terre.
- DE Gerät, bei dem der Schutz gegen einen elektrischen Stromschlag ausschließlich auf einer doppelten Isolierung und/oder einer verstärkten Isolierung beruht. Diese Geräte sind nicht mit Erdungsvorrichtungen ausgestattet.
- ES Aparato en el que la protección de la descarga eléctrica se basa únicamente en el doble aislamiento y/o aislamiento reforzado. Estos aparatos no prevén dispositivos para la puesta a tierra.
- RU оборудование, в котором защита от поражения электрическим током основана исключительно на двойной и/или усиленной изоляции. Это оборудование не предусматривает устройства для заземления.
- ZH 设备中的防电击保护器仅采用双重绝缘和/或加强绝缘。这些设备不包含接地装置。

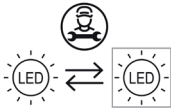

EN The LED-only light source contained in this fixture must only be replaced by the manufacturer, its support service or similarly qualified personnel.

IT La sorgente luminosa, esclusivamente led, contenuta in questo apparecchio deve essere sostituita solo dal costruttore o dal suo servizio di assistenza o da personale altrettanto qualificato.

FR La source lumineuse, exclusivement à Led et contenue dans cet appareil, doit être remplacée uniquement par le fabricant ou par son service après-vente ou encore par un personnel tout aussi qualifié.

DE Das in diesem Geräte enthaltene Leuchtmittel, ausschließlich LED, darf nur vom Hersteller oder dessen Kundendienst oder vergleichbar qualifiziertes Personal ersetzt werden.

ES La fuente luminosa exclusivamente led de este aparato la debe sustituir solamente el fabricante, el Servicio de Asistencia o personal igualmente cualificado.

RU Источник света, являющийся только светодиодом, который находится внутри этого светильника, должен заменяться только производителем или его службой поддержки или квалифицированным персоналом.

ZH 本照明设备中包含的全led光源仅可由制造商、其协助服务部门或具备同等资质的合格人员进行更换。

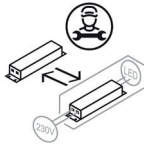

EN The LED driver contained in this fixture must only be replaced by the manufacturer, its support service or similarly qualified personnel.

IT Il driver led contenuto in questo apparecchio deve essere sostituito solo dal costruttore o dal suo servizio di assistenza o da personale altrettanto qualificato.

FR Le driver à Led contenu dans cet appareil doit être remplacé uniquement par le fabricant ou par son service après-vente ou encore par un personnel tout aussi qualifié.

DE Der in diesem Gerät enthaltene LED-Treiber darf nur vom Hersteller oder dessen Kundendienst oder vergleichbar qualifiziertes Personal ersetzt werden.

ES El controlador led de este aparato lo debe sustituir solamente el fabricante, el Servicio de Asistencia o personal igualmente cualificado.

RU Привод светодиода, находящийся внутри этого светильника, должен заменяться только производителем или его службой поддержки или квалифицированным персоналом.

ZH 本照明设备中包含的led驱动器仅可由制造商、其协助服务部门或具备同等资质的合格人员进行更换。

- EN** This product was made using specific processing techniques and treatments, aimed at creating unique results. Any differences between individual items are therefore designed to ensure that every single product is special and unique.
- IT** Questo prodotto è stato realizzato con particolari lavorazioni e trattamenti al fine di ottenere risultati unici. Per tale ragione, eventuali differenze da pezzo a pezzo sono volte a garantire specialità ed unicità ad ogni singolo prodotto.
- FR** Ce produit a été soumis à des ennobissements et des traitements spéciaux pour des résultats uniques. Pour cette raison, les éventuelles différences d'une pièce à l'autre garantissent la particularité et l'unicité de chaque article.
- DE** Dieses Produkt wurde mit speziellen Verfahren und Behandlungen hergestellt, um einzigartige Ergebnisse zu erzielen. Aus diesem Grund sind eventuelle Unterschiede von Teil zu Teil beabsichtigt, um die Besonderheit und Einzigartigkeit jedes Produkts zu gewährleisten.
- ES** Este producto se ha realizado con elaboraciones y tratamientos especiales para conseguir resultados únicos. Por ese motivo las diferencias que pueda haber entre una pieza y otra sirven para garantizar que cada producto es especial y único.
- RU** Данный продукт был реализован с применением особых методов обработки, для получения уникальных результатов. По этим причинам возможные отличия наших изделий гарантируют уникальность и особые характеристики каждого конкретного изделия.
- ZH** 为收获独具特色的效果, 本产品经由特殊工艺和处理制成。因此, 每件产品之间可能存在的任何差异均为对单件产品之特殊性和独特性的保证。

**Limited Warranty
12 months
for United States
and Canada Only**

consequential damages arising out of or relating to the PRODUCT, or other matters not specifically covered hereunder.

COVERAGE

Lodes, with headquarter in 30020 Marcon (VE), Via Pialoi 32 Italy, VAT N.: 02992370276 (hereinafter, "Lodes" or "WARRANTOR") warrants that each Lodes PRODUCT will be free from defects in material and workmanship for a period of twelve months from the date of shipment / delivery of the PRODUCT (that can be identified by the "Studio Italia Design" trademark, trade name, or logo affixed to them). The Limited Warranty is referred to herein as "the Limited Warranty." The PURCHASER's sole and exclusive remedy under this Limited Warranty for defects in the PRODUCT shall be the repair, replacement or refund of the purchase price, in WARRANTOR's sole discretion, of the defective PRODUCT, or components thereof.

NOT COVERED

This Limited Warranty also does not apply to, and WARRANTOR shall have no liability or responsibility in respect of, damages or expenses relating to:

- Any PRODUCT purchased from any entity other than WARRANTOR;
- Alteration, change or modification of the PRODUCT, including its subcomponents, parts or assemblies;
- WARRANTOR also makes no warranty that a PRODUCT manufactured does not infringe the intellectual property or other proprietary rights of any third party;
- Accidents, misuse, abuse, abnormal use, improper use, negligent use, wilful misconduct, or use exceeding the recommended and permitted limits of the PRODUCT, and / or normal wear or deterioration;
- Any defect or non-conformity that has not been timely and promptly communicated in writing to WARRANTOR as set forth herein.
 - Any damage, cost or expense caused by Act of God; or
- Loss of time, loss of use, inconvenience, loss of profits, lost business, lost business opportunities, damage to reputation, goodwill and any incidental or

PROCEDURE

Upon delivery, PURCHASER shall, with in one (3) business day, inspect the PRODUCT for conformity and visible defects. PURCHASER shall give WARRANTOR immediate written, specific and detailed notice of any non- conformities or defects regarding the PRODUCT. Upon receipt of the written notice of claim, WARRANTOR shall have the right to inspect the PRODUCT. In the event of a defect covered by this Limited Warranty, WARRANTOR will, at WARRANTOR's discretion, repair or replace the PRODUCT or any component of the PRODUCT or refund the purchase price for that particular PRODUCT. In the event that PURCHASER submits a warranty claim that, in the sole reasonable discretion of the WARRANTOR, is unfounded, the PURCHASER shall reimburse the WARRANTOR all reasonable costs incurred by the WARRANTOR in evaluating the warranty claim (i.e. travel, lodging, expert evaluations, etc.). WARRANTOR must approve, in advance and in writing, all repairs or replacements covered under or performed pursuant to this Limited Warranty. Any warranty repairs or service must be performed exclusively by WARRANTOR or other authorized representative of WARRANTOR or by another servicing facility pre-approved in writing by WARRANTOR. Acceptance of any Limited Warranty claim is not an admission that any PRODUCT or any of its component parts are defective. The PURCHASER forfeits any rights it may have under this Limited Warranty if the PURCHASER does not follow the procedure described herein.

All requests and notices under this Limited Warranty shall be directed to:

**Lodes S.r.l.,
Via Pialoi n. 32,
30020 Marcon (VE), Italy
E-mail: legal@lodes.com
Fax: +39 0414 56 73 37**

LIMITATION OF DAMAGES

Except as expressly provided by this Limited Warranty, WARRANTOR SHALL NOT BE RESPONSIBLE FOR ANY INCIDENTAL OR CONSEQUENTIAL DAMAGES ASSOCIATED WITH THE USE OR NON-USE OF THE PRODUCT OR A CLAIM UNDER THIS LIMITED WARRANTY, WHETHER THE CLAIM IS BASED ON CONTRACT, TORT OR OTHERWISE. The foregoing statements of warranty are exclusive and in lieu of all other remedies or damages. Some States do not

allow the exclusion or limitation of incidental or consequential damages, so only in this case this limitation or exclusion may not apply to you.

This Limited Warranty shall be the sole and exclusive remedy available to the PURCHASER with respect to this PRODUCT. In the event of any alleged breach of any warranty or any legal action brought by the PURCHASER, based on breach of warranty, alleged negligence or other tortious conduct by WARRANTOR, the PURCHASER's sole and exclusive remedy will be the repair or replacement of any defective PRODUCT as stated herein. In no event shall the liability of the WARRANTOR exceed the purchase price of the PRODUCT.

DISCLAIMER. ANY IMPLIED WARRANTY OF MERCHANTABILITY OR FITNESS FOR A PARTICULAR PURPOSE AND ALL IMPLIED WARRANTIES ARISING FROM A COURSE OF DEALING, USAGE OF TRADE, BY STATUTE OR OTHERWISE, IS HEREBY STRICTLY LIMITED TO THE TERM OF THIS WRITTEN WARRANTY. This Limited Warranty shall be the sole and exclusive remedy available to the PURCHASER with respect to this PRODUCT. In the event of any alleged breach of any warranty or any legal action brought by the PURCHASER based on alleged negligence or other tortious conduct by WARRANTOR, the PURCHASER'S sole and exclusive remedy will be repair or replacement of defective materials or refund of the purchase price, as stated herein.

TRANSFER OF LIMITED WARRANTY

This warranty is made by WARRANTOR with only first PURCHASER of the PRODUCT and does not extend to any subsequent PURCHASER or any third parties. The unexpired portion of this Limited Warranty may not be transferred to any entity.

APPLICABLE LAW

This Limited Warranty shall be deemed to have been particularly negotiated between parties. The parties expressly acknowledge and irrevocably agree that any and all claims or disputes arising out of or otherwise relating to this Limited Warranty shall be decided exclusively by Court of Venice under Italian Law with the exclusion of any courts of any place. PURCHASER expressly waives any provision of law in the jurisdiction in which PURCHASER is located or any other potentially applicable law which conflicts with any provision of this Limited Warranty at any time.

OTHER RIGHTS

Your acceptance of delivery of The PRODUCT constitutes your acceptance of the terms of this Limited Warranty. This Limited Warranty gives you

specific legal rights, and you may also have other rights which vary from state to state. If any term or provision of this Limited Warranty is invalid or unenforceable under any local, state, or federal law, statute, judicial decision, regulation, ordinance, executive order or other rule of law, such term shall be deemed reformed or deleted, but only to the extent necessary to comply with such statute, regulation, ordinance, order or rule and the remaining provisions of this Limited Warranty shall remain in full force and effect.

ENTIRE AGREEMENT

This document alone contains the entire Limited Warranty given by WARRANTOR in respect of the PRODUCT. Nothing in WARRANTOR's product literature, marketing materials, advertisements and technical specifications expand or enlarge the scope of this Limited Warranty. There are no terms, promises, conditions or warranties regarding the PRODUCT other than those expressly contained herein. WARRANTOR specifically does not authorize any person, including but not limited to any dealer or other agent or employee of WARRANTOR, to extend the time, scope, terms or conditions of this Limited Warranty or to create or assume for WARRANTOR any other obligation or liability with respect to the PRODUCT or other products designed, manufactured or sold by WARRANTOR. All terms of this Limited Warranty are contractual and not mere recitals, and constitute material terms of this Limited Warranty. It is agreed and acknowledged that the provisions of this Limited Warranty allocate the risks between WARRANTOR and PURCHASER, that WARRANTOR's pricing reflects this allocation of risk, and but for this allocation and limitation of liability, WARRANTOR would not have entered into this Limited Warranty. The agents, employees, and dealers of Lodes Products are not authorized to make modifications to this limited warranty or make additional warranties binding on Lodes. **THIS DOCUMENT AND ALL PROVISIONS CONTAINED HAS BEEN SPECIFICALLY AGREED BETWEEN THE PARTIES.**

Head offices & showroom

Lodes, via Pialoi 32,
30020 Marcon (Venezia) Italy
T +39 041 45 69 266
info@lodes.com

@lodesbrand



See Diesel Living with Lodes
collections



Lodes Milan showroom

via della Moscova 33,
Cortile della Seta
20121 Milano (MI) Italy
T +39 02 4940 0999
milano@lodes.com